

# Sliding Pocket Wall w/ Soft-Close, 4 Panels, Symmetrical

(SPW4S-SC)

ELEVATION

RAYDOOR STANDARD  
SYSTEM DRAWINGS  
©2020



YOUR OPENING HEIGHT = PANEL + 2<sup>5</sup>/<sub>8</sub>"  
YOUR OPENING WIDTH = (4 x PANEL) - 6"

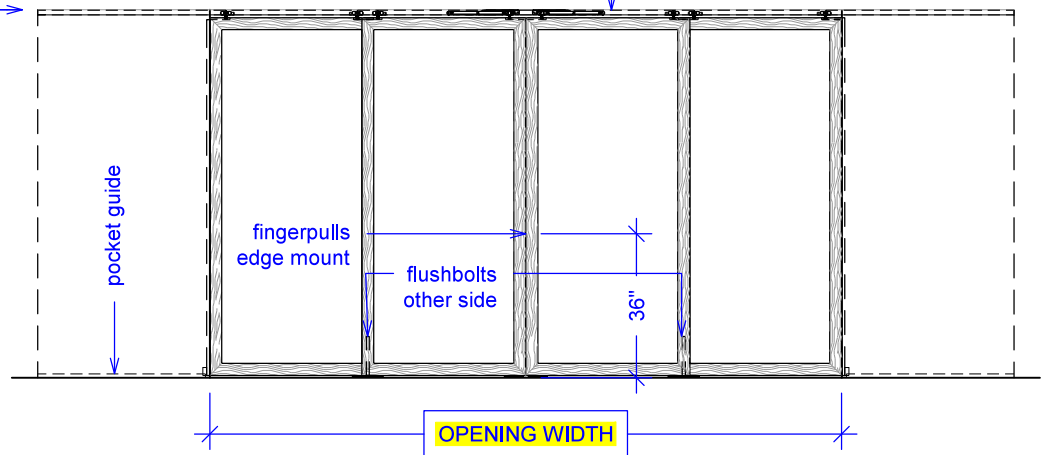
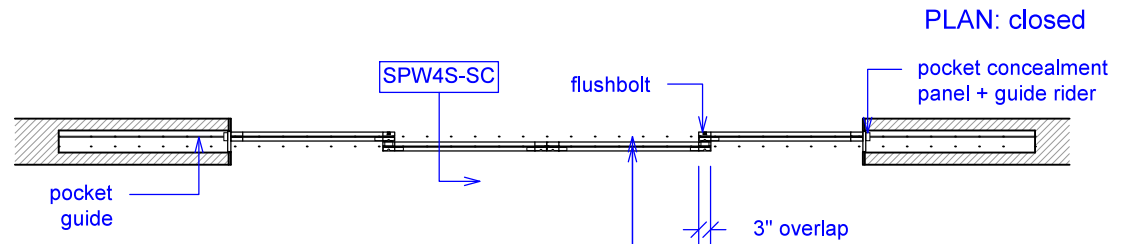
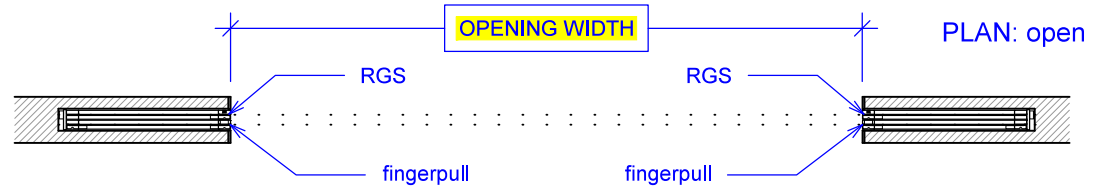
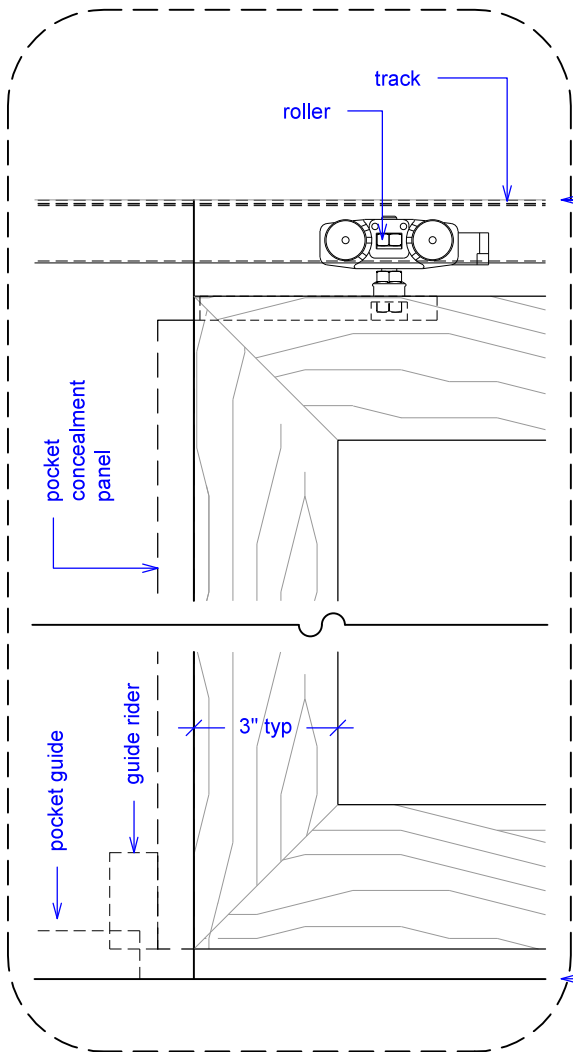

# Sliding Pocket Wall w/ Soft-Close, 4 Panels, Symmetrical

(SPW4S-SC)

SECTION

RAYDOOR STANDARD  
SYSTEM DRAWINGS  
©2020

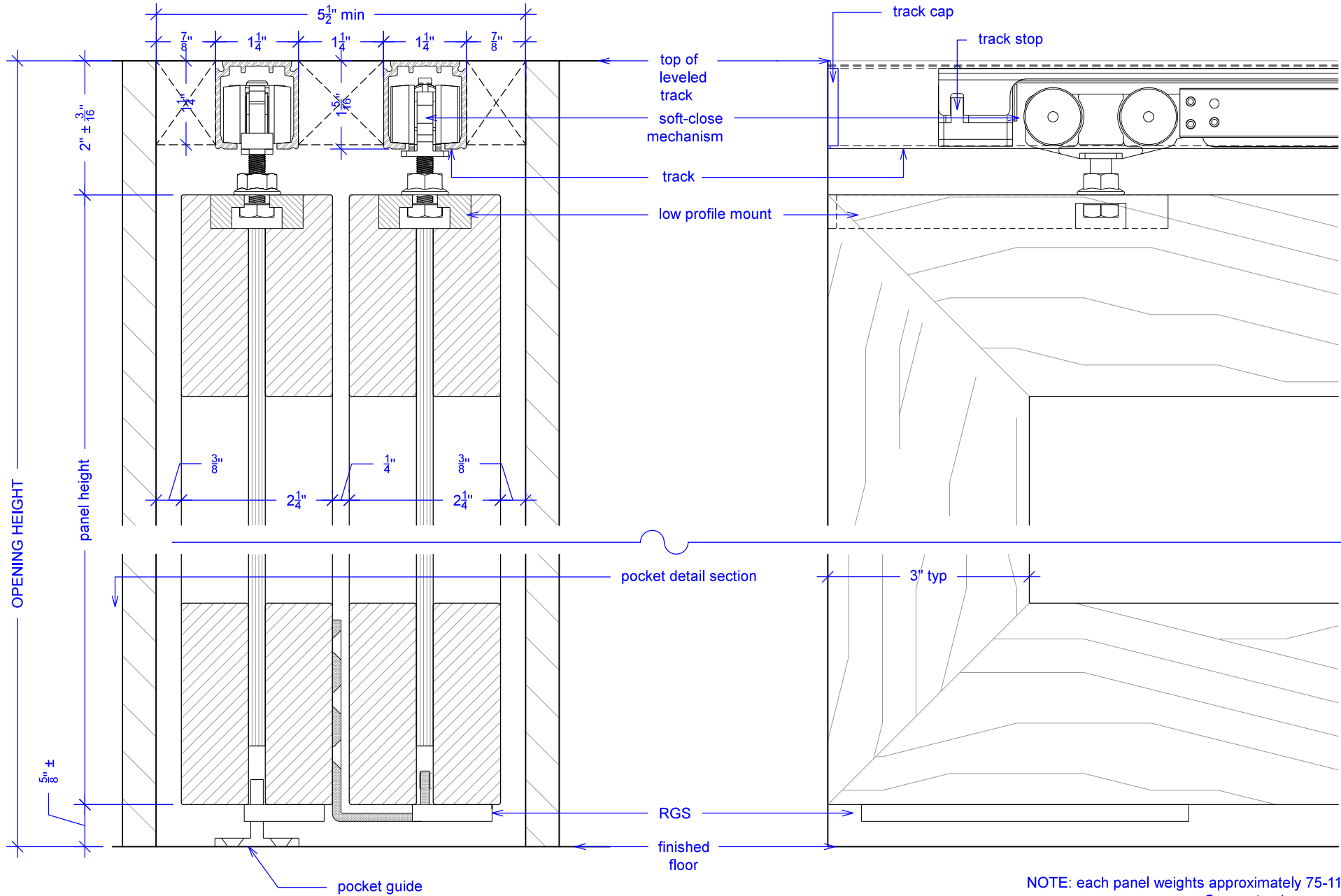

NOTE: each panel weights approximately 75-110 lbs.  
Secure tracks accordingly.

# Sliding Pocket Wall w/ Soft-Close, 4 Panels, Symmetrical

(SPW4S-SC)

## SOFT-CLOSE HARDWARE

RAYDOOR STANDARD  
SYSTEM DRAWINGS  
©2020

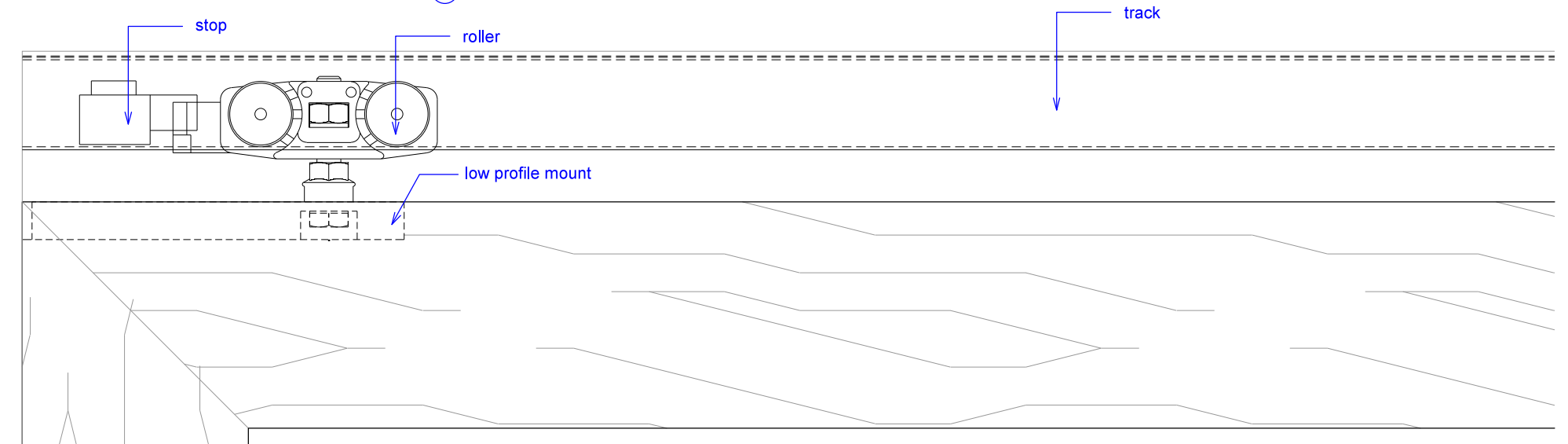
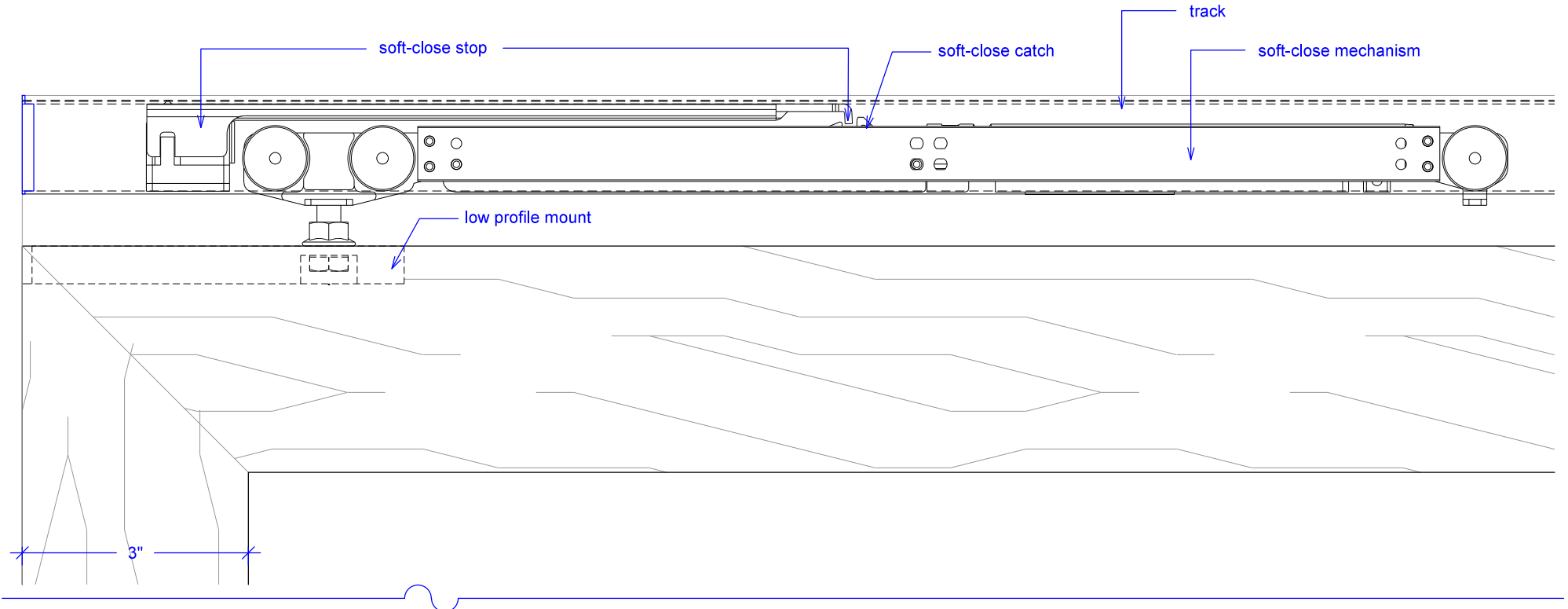

# Sliding Pocket Wall w/ Soft-Close, 4 Panels, Symmetrical

(SPW4S-SC)

## POCKET DETAIL

RAYDOOR STANDARD  
SYSTEM DRAWINGS  
©2020



NOTE: pocket depth should be 2"  
deeper than width of doors

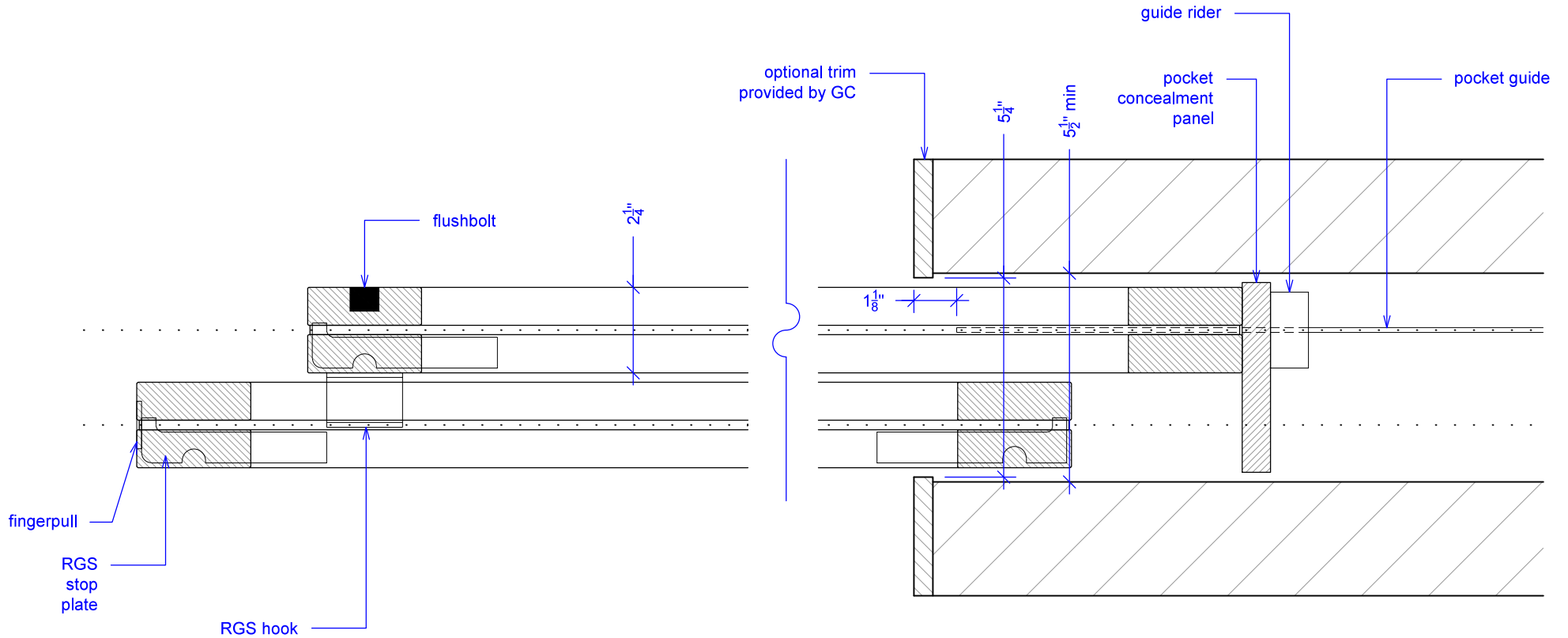

Guide rider is a block with a slit for the pocket guide; it allows for full extension, attach to bottom of concealment panel.

# Sliding Pocket Wall w/ Soft-Close, 4 Panels, Symmetrical



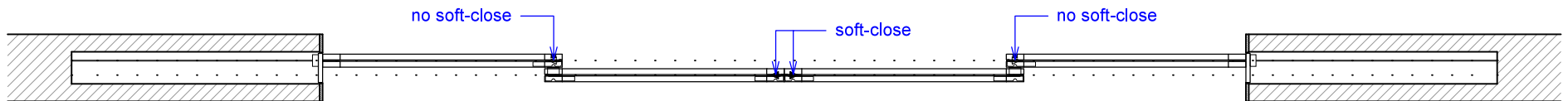

(SPW4S-SC)

## OPERATION OVERVIEW

RAYDOOR STANDARD  
SYSTEM DRAWINGS  
©2020



KEY:

 RGS hook	 RGS stop	 pocket guide	 track stop	 stopper / release device
--	--	--	--	--