

Sliding Pocket w/ Soft-Close, 1 Panel

(SP1-SC)

ELEVATION

RAYDOOR STANDARD
SYSTEM DRAWINGS
©2020

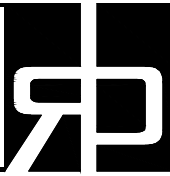

PLAN: open

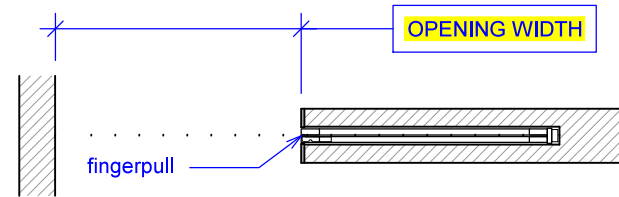

PLAN: closed

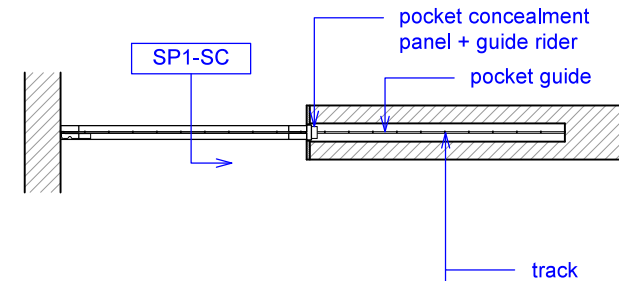

ELEVATION: closed

YOUR OPENING HEIGHT = PANEL + 2⁵/₈"
YOUR OPENING WIDTH = PANEL

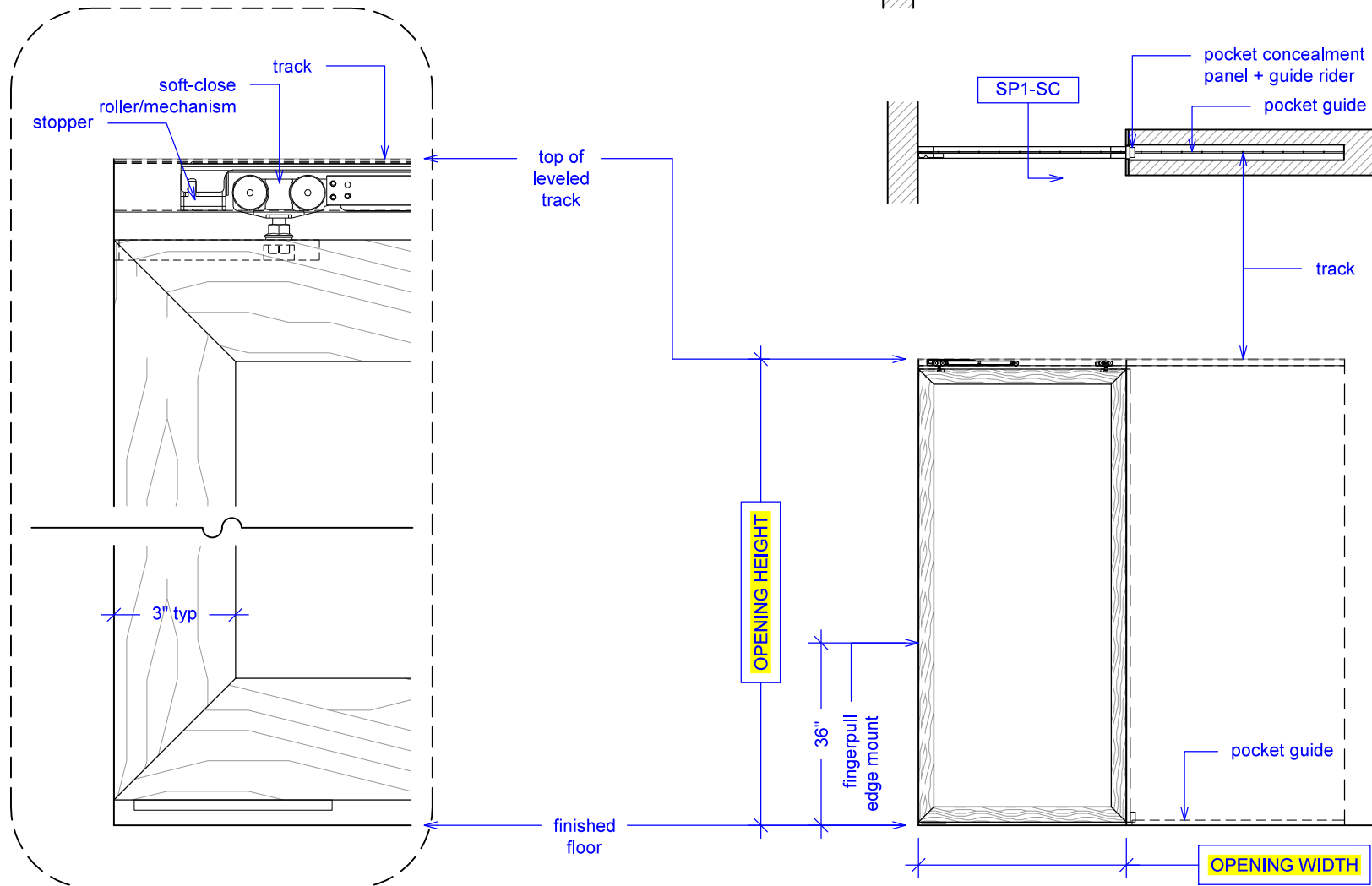

Sliding Pocket w/ Soft-Close, 1 Panel

(SP1-SC)

SECTION

RAYDOOR STANDARD
SYSTEM DRAWINGS
©2020

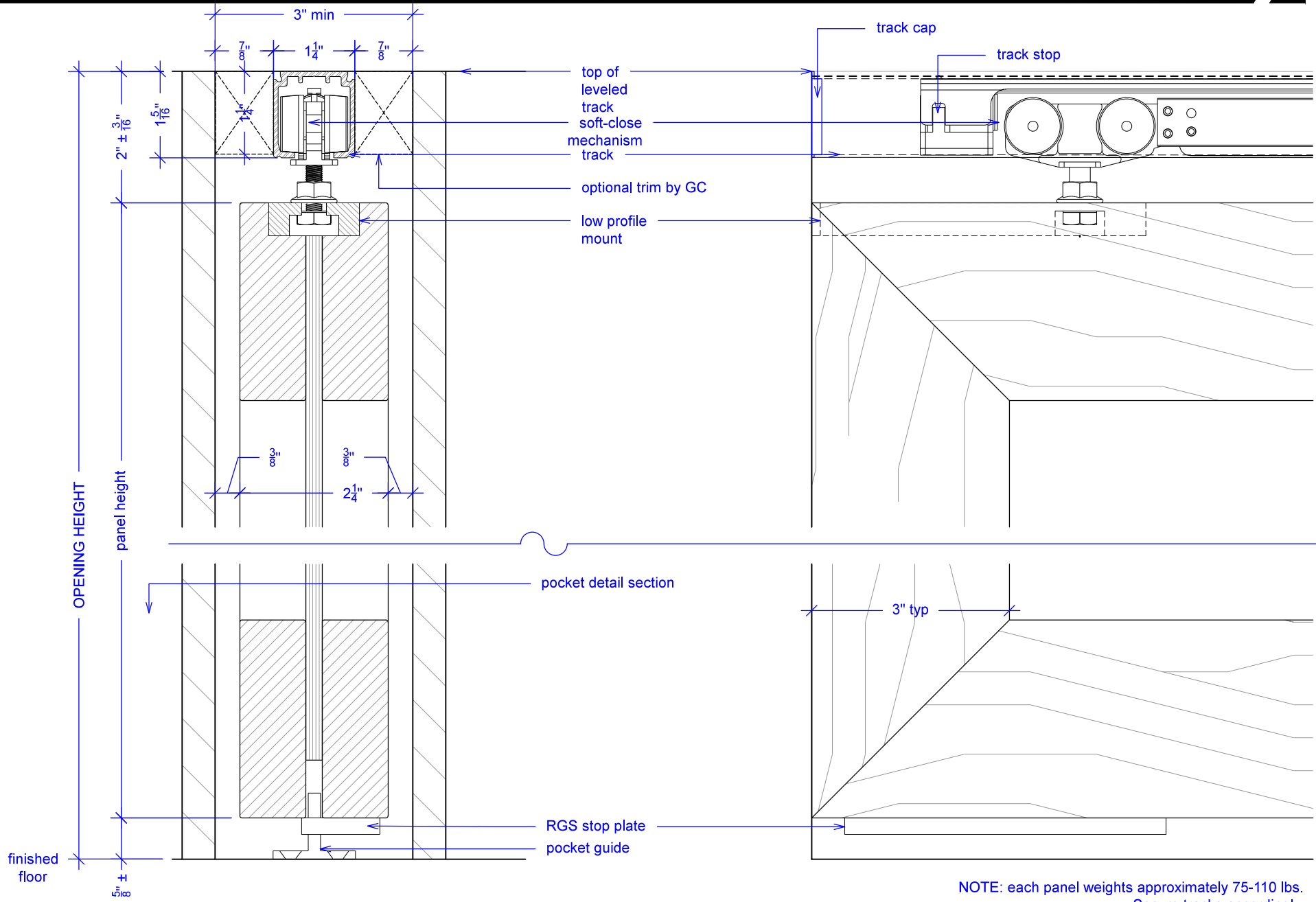

NOTE: each panel weights approximately 75-110 lbs.
Secure tracks accordingly.

Sliding Pocket w/ Soft-Close, 1 Panel

(SP1-SC)

SOFT-CLOSE HARDWARE

RAYDOOR STANDARD
SYSTEM DRAWINGS
©2020

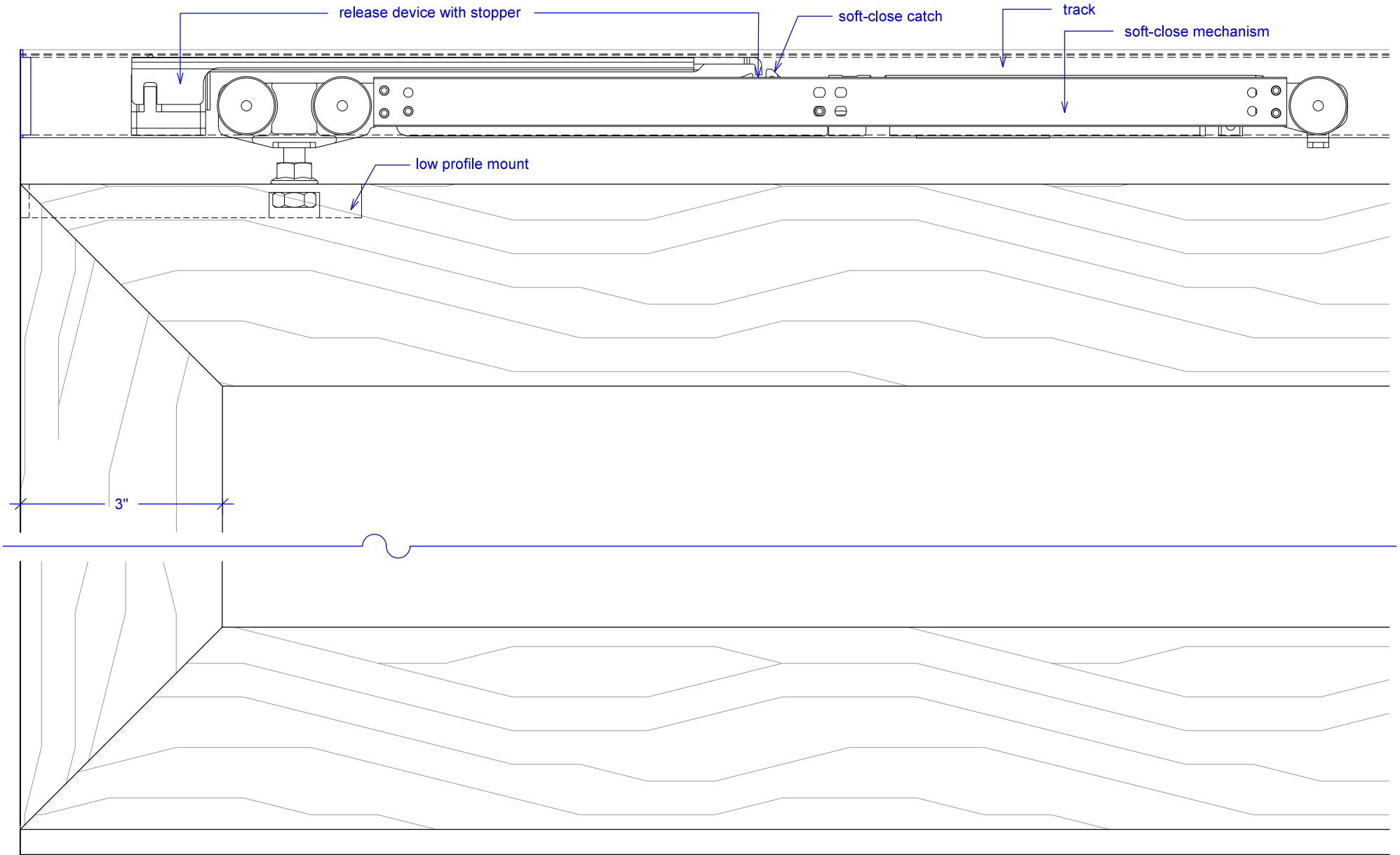

Sliding Pocket w/ Soft-Close, 1 Panel

(SP1-SC)

POCKET DETAIL

RAYDOOR STANDARD
SYSTEM DRAWINGS
©2020



NOTE: pocket depth should be 2"
deeper than width of doors

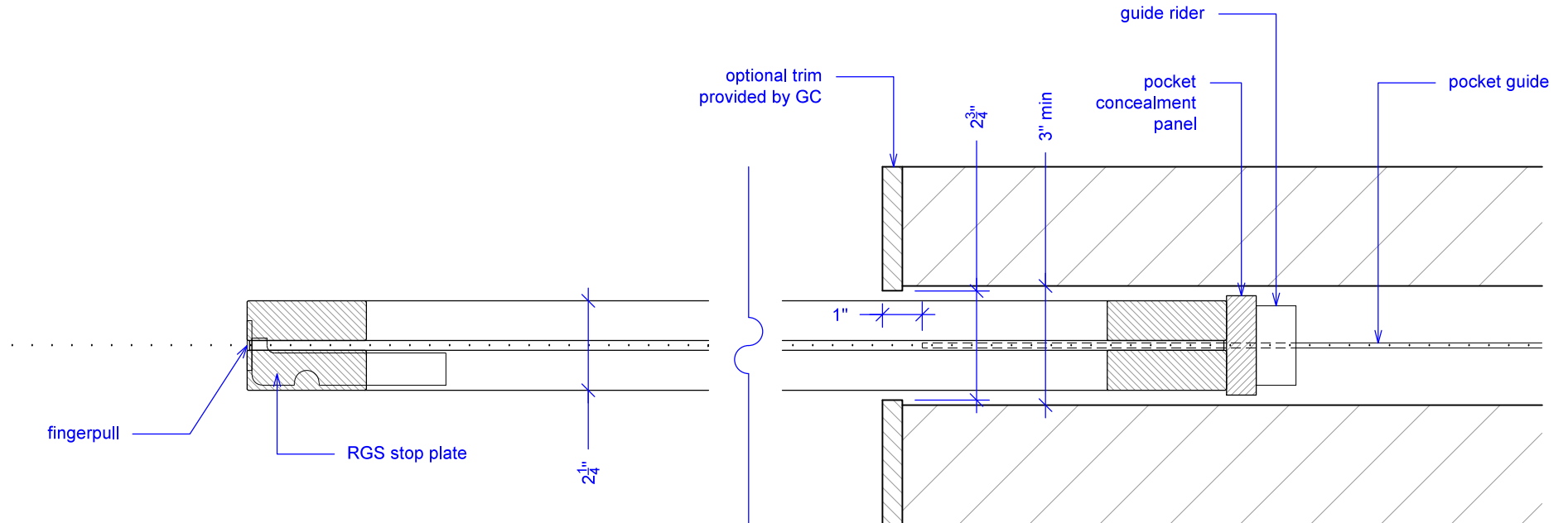

Guide rider is a block with a slit for the pocket guide; it allows for full extension, attach to bottom of concealment panel.

Sliding Pocket w/ Soft-Close, 1 Panel

(SP1-SC)

OPERATION OVERVIEW

RAYDOOR STANDARD
SYSTEM DRAWINGS
©2020

